

KE-8254S

AIR AUTO. SEAT VALVE (FOOD & SANITARY GRADE) CLAMP ENDS (3A STANDARD) AND BUTT-WELD ENDS

MATERIAL: BODY S.S. 316, CLAMPS S.S. 304
SIZE: 1-1/2" thru 3"

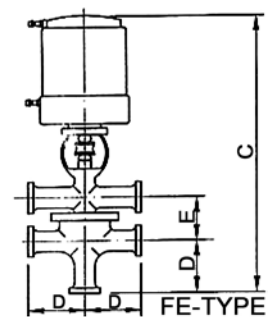
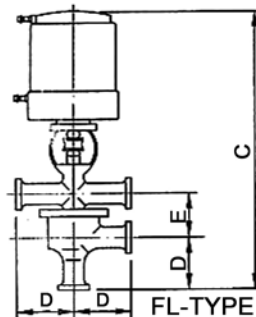
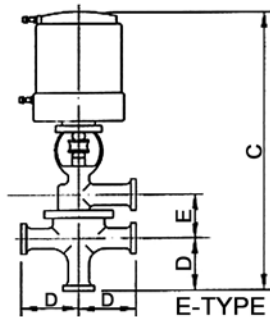
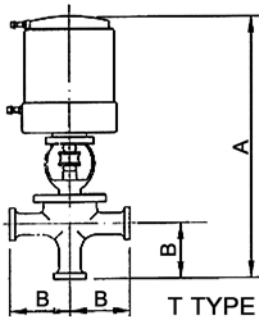
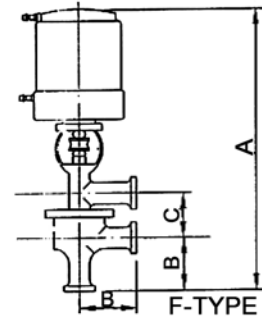
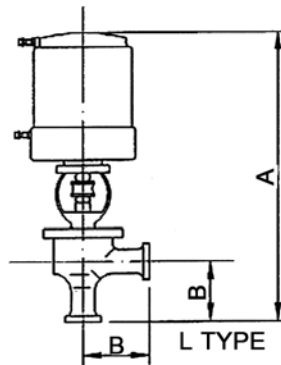
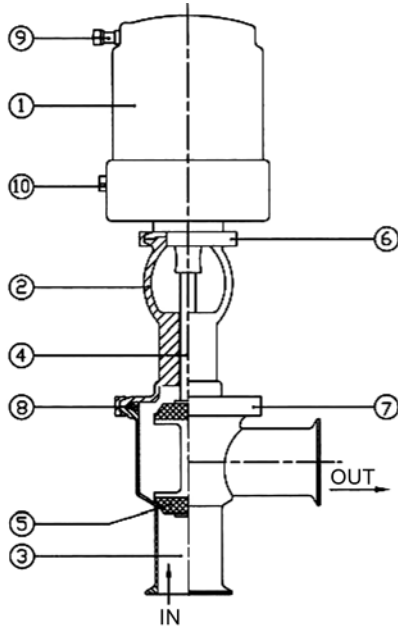

DIMENSIONS

Unit:mm

SIZE	A	B	C	D	E
1-1/2"	352	70.3	454	70.3	82.5
2"	378	89.3	492	89.3	95.3
2-1/2"	384	89.3	511	89.3	108.0
3"	397	95.7	537	95.7	120.6

MATERIALS LIST

NO	PART NAME	MATERIAL	NO	PART NAME	MATERIAL
1	ACTUATOR	SS 304	6	CLAMP	SS 304
2	UPPER BODY	SS 316	7	CLAMP	SS 304
3	LOWER BODY	SS 316	8	GASKET	SILICONE
4	"TR" STEM	SS 316	9	INLET	BRONZE
5	STEM SEAT	TEFLON	10	OUTLET	BRONZE